

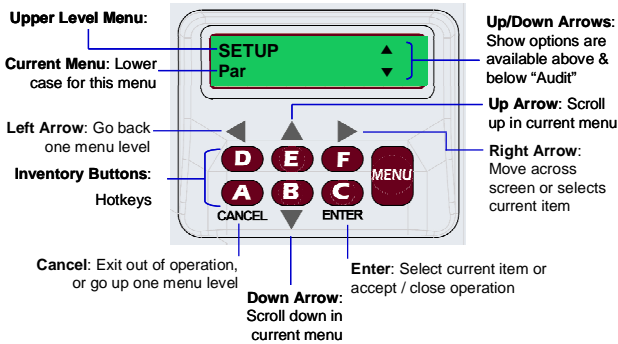

Quick Reference Guide V5.16

Menu Navigation



Guardian G6 XL "Hotkeys"

- A TO F** Displays Coin Denomination And Quantity For Selected Tube (A to F) Also Used For Manual Payout
- MENU** Main Menu
- MENU > MENU** Begins Audit Current Data Reporting
- E + F** Establishes Par At Current Change Levels
- D + F** Disables Par Mode
- D + E** Change Language
- MENU** Hold for 5 seconds Enables / Disables Key Pad lock out
- E + MENU** Initiates Manual Fill Mode
- A + B** Initiates Tube Coin Count Scanning
- D + F** Disables Par Mode
- D + A** Shows Payout Cassette Coin Configuration
- F + C** Initiates Par Paydown (if enabled)

Quick Set Up Guide

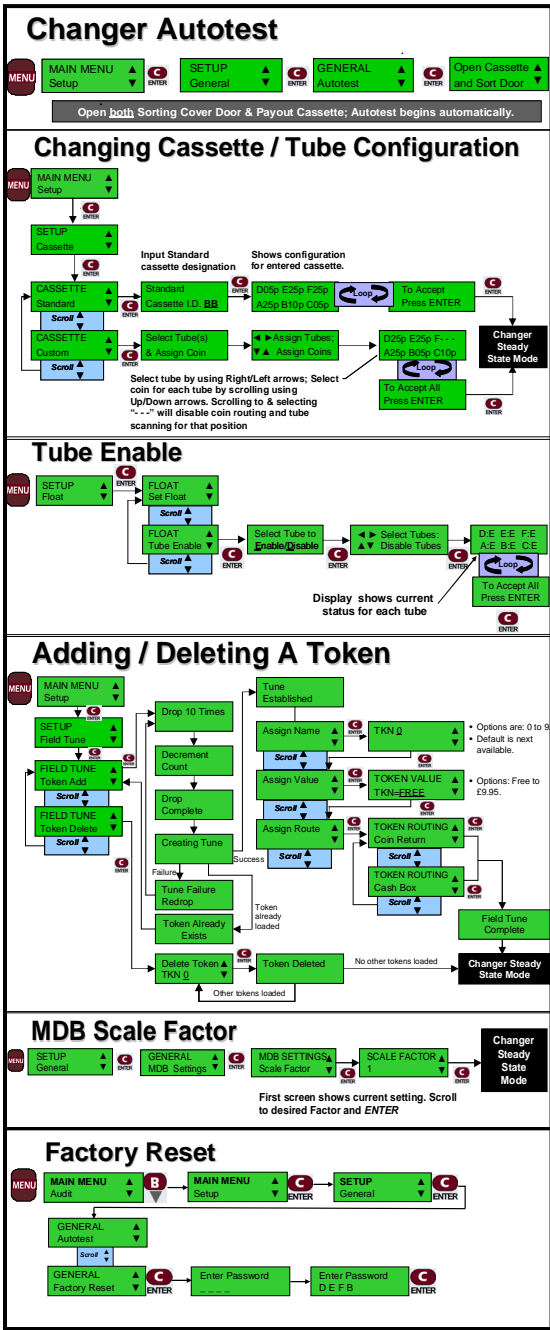

Display

- Sort Door Open
- Cassette Door Open
- Payout Jam Tube X
- Tube Sense Tube X
- Low Power Condition
- Tube Cassette Not Defined
- Check Coin Path
- Sorting Error
- Escrow Detected

Warning Messages

- The Sorting Door has not been closed properly.
- The Payout Cassette has not been closed properly.
- The noted coin tube has had a payout problem. Remove the Payout Cassette, check that tube and the payout drive belt assembly.
- The noted coin tube level reading is inaccurate due to some interference. Please check for any obstructions.
- Power to the changer has dropped below the recommended MDB power level.
- The changer has an unknown Payout Cassette or tube configuration and cannot route coins. Please see *Cassette Configuration*.
- There is a problem in the Acceptor Validation or Sorting area and these should be checked. Cleaning is most likely required.
- There is a problem in the Sorting section. Please open the Sorting Door and check the area. After correction, drop coins to clear the warning message.
- The Escrow Lever is depressed enough to open the acceptor gate or there is a jam in the Acceptor Validation area. Please check these areas.

Out Of Service Messages

- Out-of-Service Payout Motor
- Out-of-Service Communication
- Out-of-Service Tube Sense

- The changer has a serious internal error and is not operational. Please take it to a Coinco authorized Service Center for service.
- There are multiple tube sense errors and the changer is not operational. Please take it to a Coinco authorized Service Center for service.
- The changer has a Payout Motor problem and is not operational. Please take it to a Coinco authorized Service Center for service.

Payout Cassette

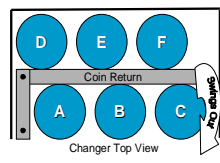

Tube Capacity		
Denomination	No. Coins	Value
0.10 zł	91	9.10 zł
0.20 zł	89	17.80 zł
0.50 zł	86	43.00 zł
1.00 zł	84	84.00 zł
2.00 zł	70	140.00 zł
5.00 zł	71	355.00 zł



Guardian G6XL Cassette Configurations							
Cassette	Country	Coin Denomination By Tube					
		A	B	C	D	E	F
BB	Poland	0.10 zł	1.00 zł	2.00 zł	0.10 zł	0.20 zł	0.50 zł

Executive Main Menu Structure

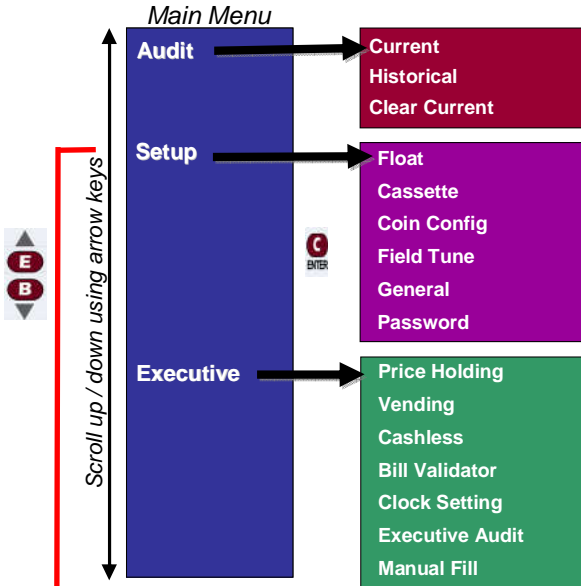

Setup Menu Structure

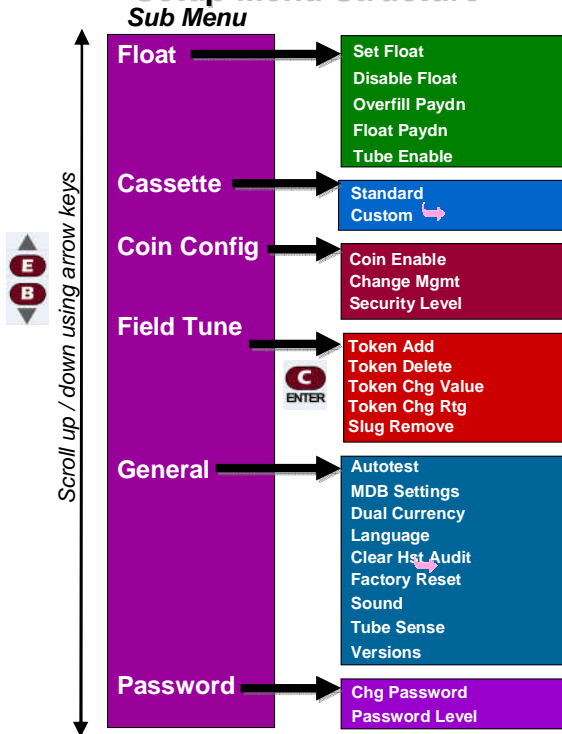

Executive Sub Menu Structure

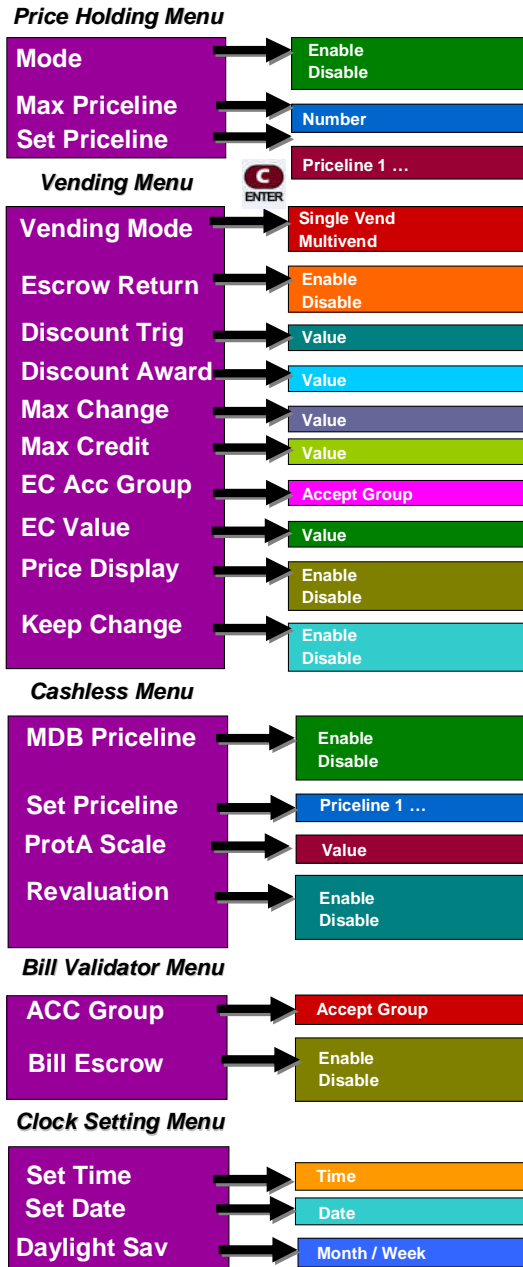

Executive Audit Menu

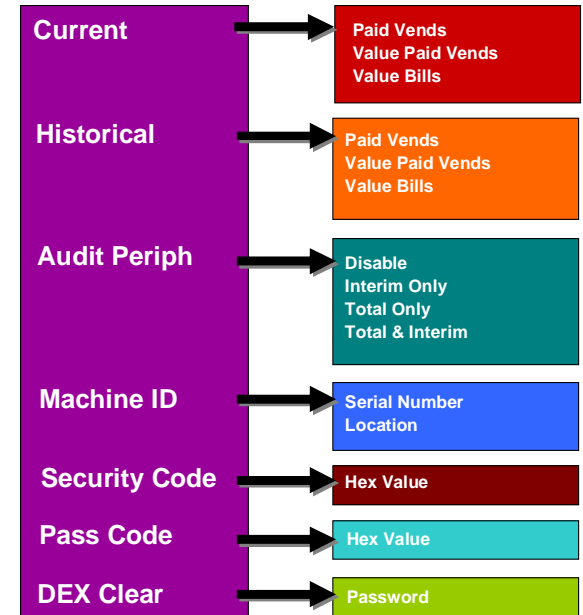

Password Protection Levels

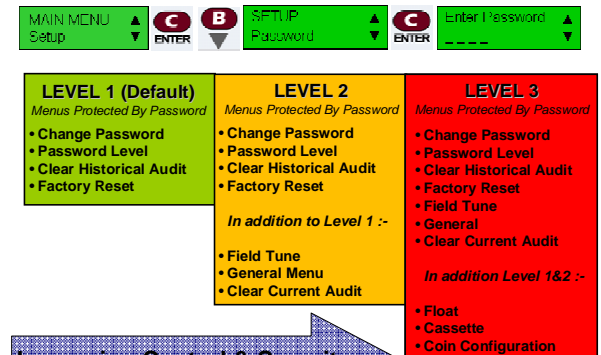

Increasing Control & Security

VANTAGE™

Engineers Quick Reference Guide V1.1

Model Number Description

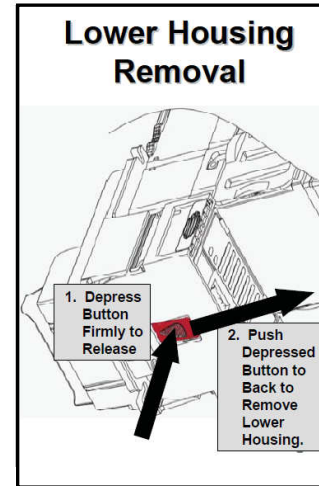
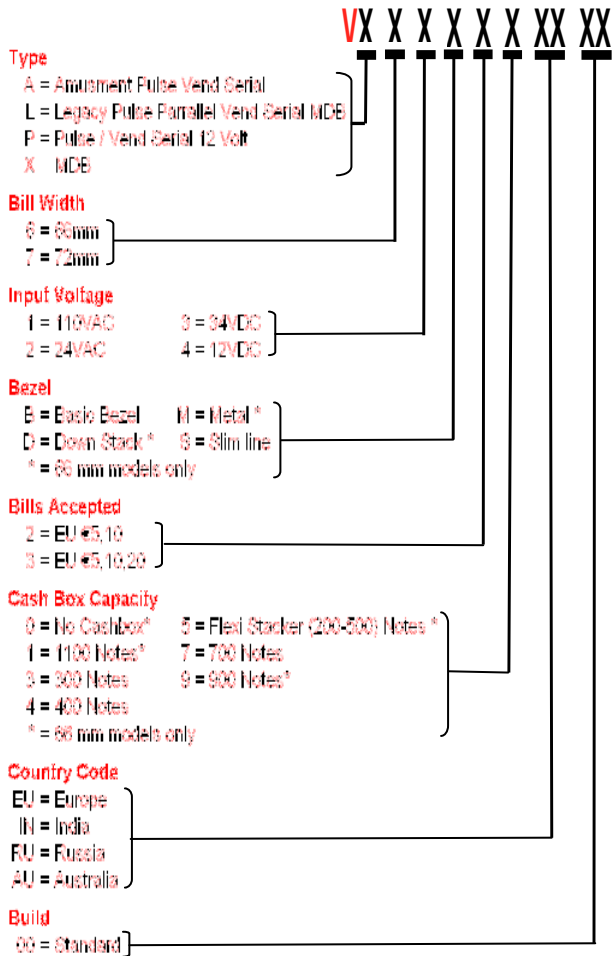

Diagnostic Flash Codes

Flash Code	Validator Status
GREEN (solid)	Sales Mode / OK
GREEN x 1	Coupon Teach *
GREEN x 2	Service Mode
YELLOW x 1	Clean Unit
YELLOW x 2	Service Unit
RED x 1	Cashbox Full
RED x 2	Clear Bill Path
RED x 3	Out of Service

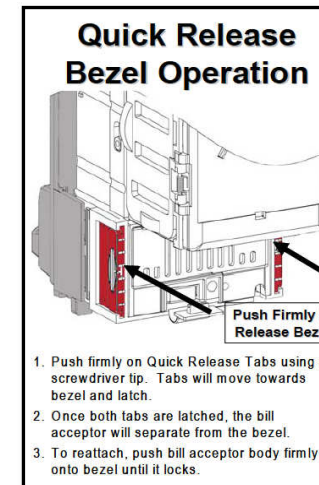
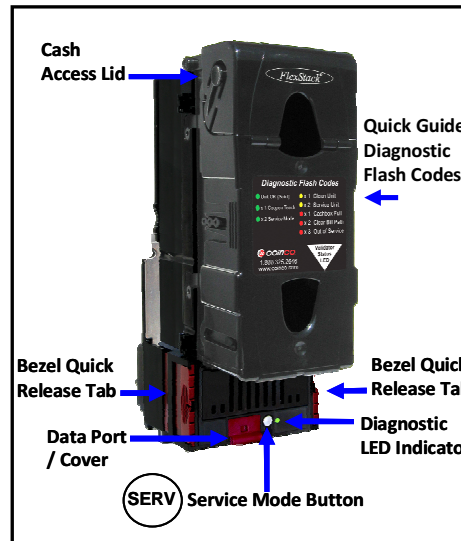

Vantage Bill Acceptance					
Model	Bill Width	10.00 zł	20.00 zł	50.00 zł	100.00 zł
VX73B43PL00	72mm	✓	✓	✓	✓

To Configure Options

#	Action	Mode	Diagnostic Light
1.	Hold button until Diagnostic LED flashes.	Service	x 2

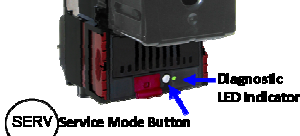

2.	Remove Lower Housing	Config	
----	----------------------	--------	--

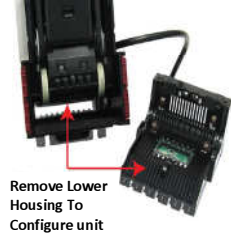

4.	Re-install Lower Housing. Inlet LEDs flash 5 times confirming options are saved.	Sales or Ready	
5.	Test Unit to Ensure Proper Setup.		

Add / Remove Options

#	Action	Mode	Diagnostic LED	Bill Inlet LEDs
1.	Hold until Diagnostic LED flashes.	Service	x 2	
2.	Hold button until Inlet LEDs flash.	Coupon Teach	(flash)	(flash)
3.	Insert Coupon to be Added or Removed .			
ADD Coupon				
4a.	Coupon accepted and returned.	Coupon Teach	(fast rate)	(fast rate)
5a.	Automatically returns to Sales Mode. Coupon addition complete.	Sales	(solid)	(cycle)
REMOVE Coupon				
4b.	Coupon disabled and returned.	Coupon Teach	(fast rate)	(fast rate)
5b.	Automatically returns to Sales Mode. Coupon removal complete.	Sales		(cycle)
Coupon NOT Recognized				
4c.	Coupon returned. Inlet LEDs flash at original rate.	Coupon Teach	(flash)	(flash)
5c.	Insert another coupon (see Step 2 above) Hold button to return to Sales Mode (note unit returns automatically after 40 secs of inactivity).		- OR -	

Factory Default

To return the Vantage to its original factory configuration. Turn off the power to the bill validator. Depress and hold in the mode button and turn on the power to the bill validator.

Warning: All user-set Configurations will be lost by returning the unit to the original factory configuration!

Default Settings

Vx73 x3xEU00 (€5 €10 €20)

Inlet LED On: Option ENABLED Inlet LED Off: Option DISABLED

Page 1	Bill Acceptance €5 €10 €20 Reserved Flash x1
Page 2	Coupons /Security / Bezel Lights Coupons High Impulse Smart Security Bezel™ Flash x2
Page 3	Bill Acceptance / Orientation 1-Way 2-Way Reserved Flash x3 4-Way (Both)
Page 4	Level 3 Security Level 3 Security Reserved Flash x4

Vx63 x2xEU00 (€5 €10)

Inlet LED On: Option ENABLED Inlet LED Off: Option DISABLED

Page 1	Bill Acceptance €5 €10 Reserved Flash x1
Page 2	Coupons /Security / Bezel Lights Coupons High Impulse Smart Security Bezel™ Flash x2
Page 3	Bill Acceptance / Orientation 1-Way 2-Way Reserved Flash x3 4-Way (Both)
Page 4	Level 3 Security Level 3 Security Reserved Flash x4

Options Navigation

Press once	Scrolls to next set of options within current Page.
Hold for next Page	Scrolls to next Page of options.

Smart Bezel™

Communicates to Customer Which Bills Are Accepted
Feature not available on all models



- €5 €10 Is Lit When: Both bills accepted an change can be made for them
- €5 Only Is Lit When : Change can only be made for €5 bills

Configuration Settings

Inlet LED On: Option ENABLED Inlet LED Off: Option DISABLED

Page 1	Bill Acceptance Flash x1
Page 2	Coupons /Security / Bezel Lights Coupons High Impulse Smart Security Bezel™ Flash x2
Page 3	Bill Acceptance / Orientation 1-Way 2-Way Reserved Flash x3 4-Way (Both)
Page 4	Level 3 Security Level 3 Security Reserved Flash x4

Diagnostic Flash Codes

Flash Code	Validator Status
(solid)	Sales Mode / OK
x 1	Coupon Teach *
x 2	Service Mode
x 1	Clean Unit
x 2	Service Unit
x 1	Cashbox Full
x 2	Clear Bill Path
x 3	Out of Service



For A Changing World.™